

# ASSEMBLY INSTRUCTIONS

**FORKLIFT BRAND**

***HYUNDAI***

**FORKLIFT MODEL**

***18 / 20 BT / B-9***

**DESCRIPTION**

***RIGID CABIN  
HEATER***

## Tracking changes and improvements

<i>Index</i>	<i>Date</i>	<i>Description of changes</i>	<i>Realised by :</i>	<i>Modified by :</i>
A	05/05/2014	Création du document	PN	
B	14/05/2014	Change to fix the rear panel	PN	
D				
E				
F				
G				
H				
I				

You can download on our website [www.cabine-kbo.com](http://www.cabine-kbo.com) the latest versions of Assembly Instructions

## Assembly Sequence

- A. Assembly of ROOF
- B. Assembly of FRONT PANEL
- C. Assembly of REAR PANEL
- D. Assembly of METAL DOORS
- E. Assembly of ELECTRIC EQUIPMENT
- F. Assembly of HEATER

## A. Assembly of ROOF

1. Clean the upper part of the over head guard OHG profiles, then stick the seal (1) following the red lines

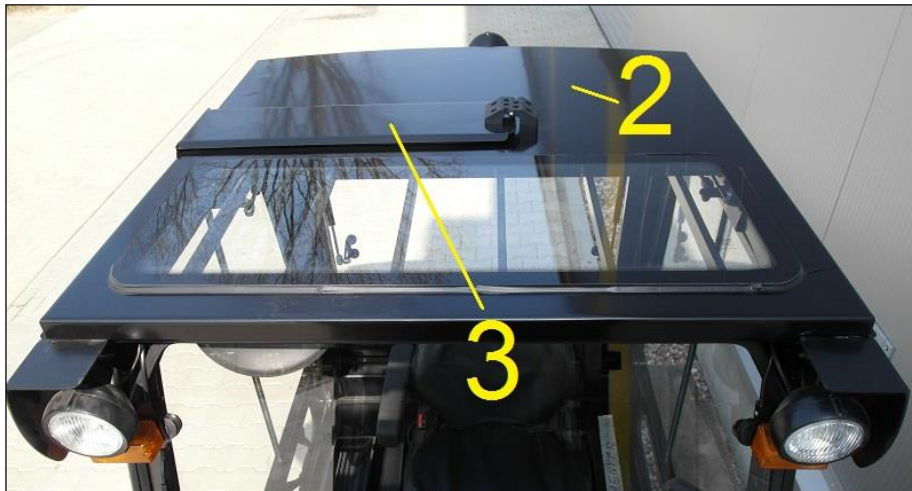
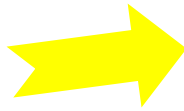

2. Put the roof (2) on the of OHG and place the following passage for access to batteries (3). Put the lateral gap equal.

3. Fasten the roof to the OHG using clamps (4). Use M8x25 screws and washer

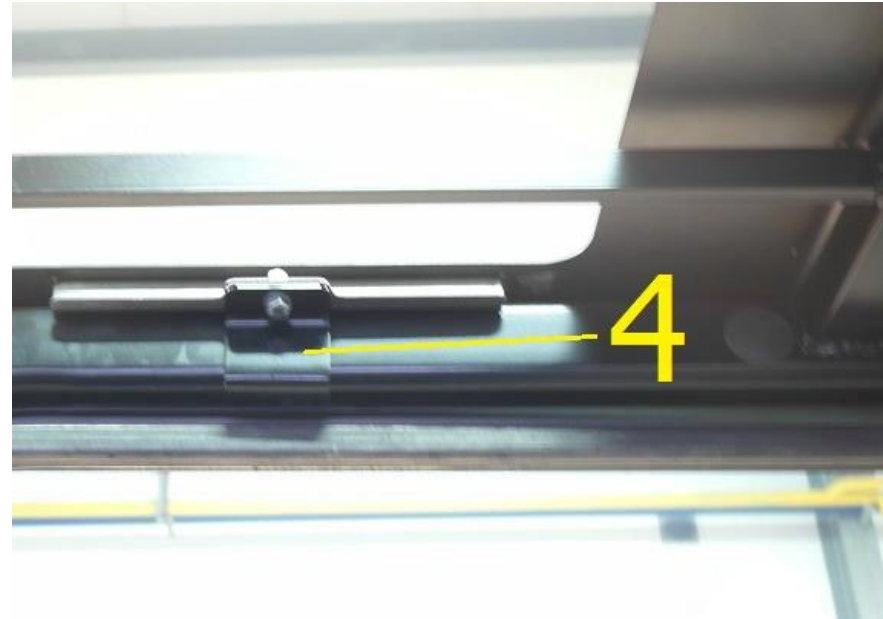
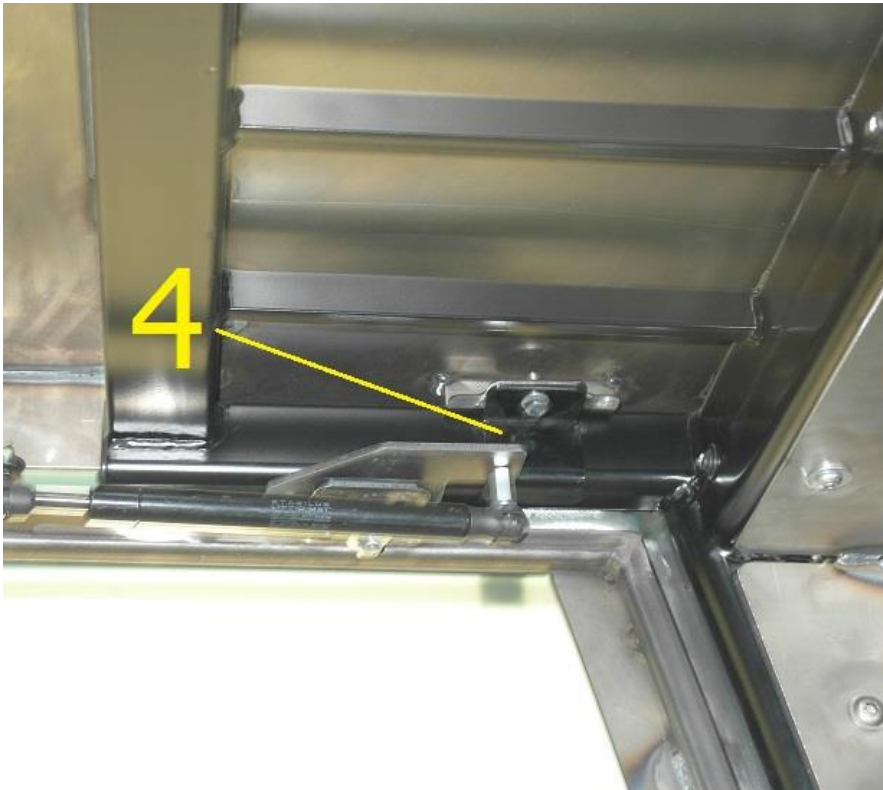

## B. Assembly of FRONT PANEL

1. Dismount the front lights and turn signals
2. On the inner face of the upper front cross member (1), remove plastic plugs to protect originals holes
3. Put in to originals holes, imbedded nuts M8

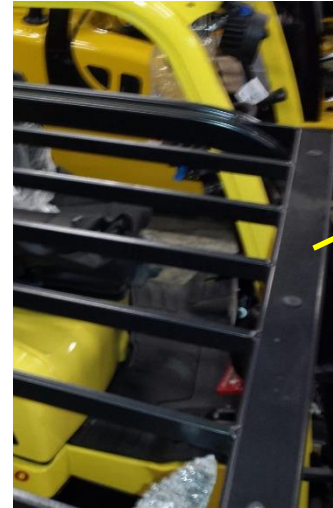

4. Screw the upper metal sheet (2) to the original holes using M8x20 screws

5. On the front metal sheet of the forklift, remove plastic plug (3)
6. Put in original holes, imbedded nuts M8

3



4



7. Screw the lower front sheet (4) to the OHG original holes using M8x20 screws

8. Mounted on the front glass 4 sheet metal (5) according to the sketch. Be careful when clamping, don't block parts

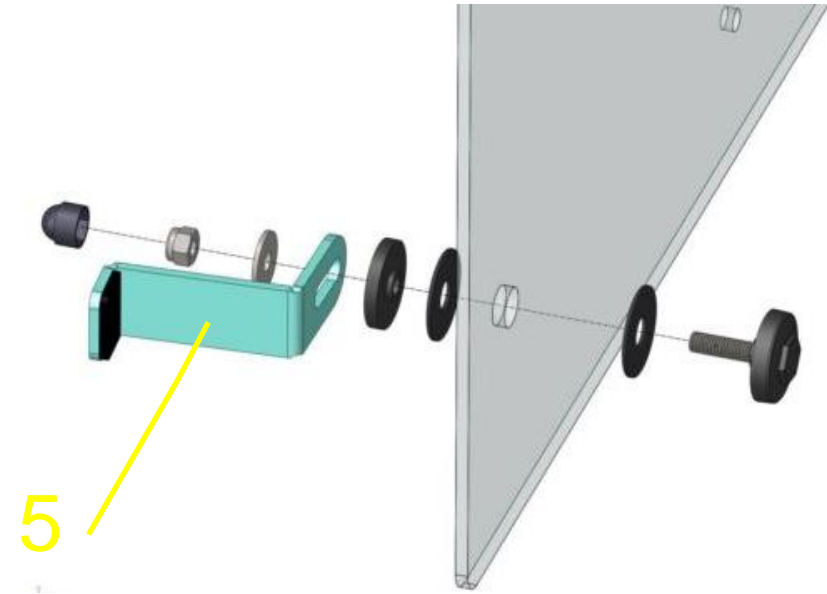

9. Check that the seal of the glass plate

10. Lock the position of the front glass by turning the sheet metal (5) mounted

**BE CARREFUL!** In order not to break the glass achieve a pressure at the outside of the front attachment point

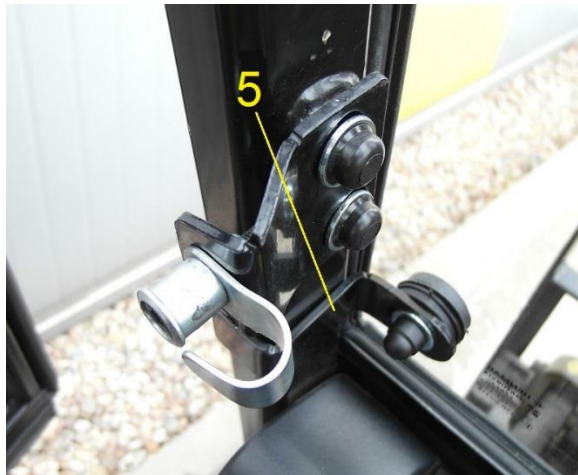



### C. Assembly of REAR PANEL

1. On the rear upper crossbar, remove plastic plugs (1) and put threaded inserts M8.No in the hole (3) because you will use it for the electric wire of rear motor wiper
2. On the inside of the rear profile of the OHG, remove plastic plugs (2) and put threaded inserts M10.

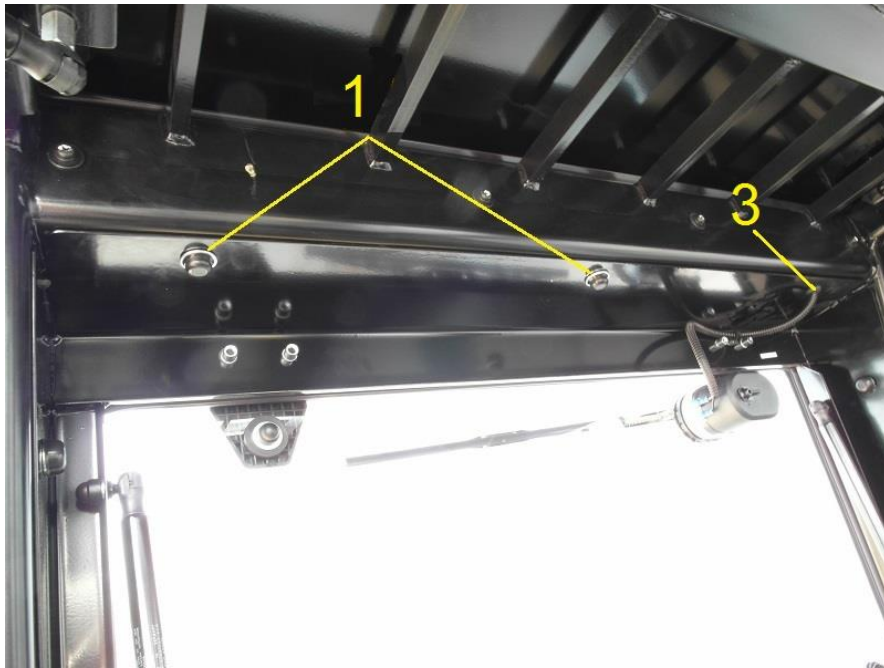

3. Put the rear panel between the rear profiles of the OHG and screw it with 2 screws HM10x25 and 2 screws M8x20



4. Fasten the rear lower sheet (3) to the rear frame using M6x15 knobs



5. Seal marked edges using silicone

## D. Assembly of METAL DOORS

1. Unscrew the handle (1)
2. Now screw the handle on the support provide (2)



3. Remove plastic plugs (3) and (4) on the original holes
4. Put threaded nuts M10 in the holes (3) and put threaded nuts in the holes (4)

5. Screw the door hinges to the original holes (3) using M10x30 screws

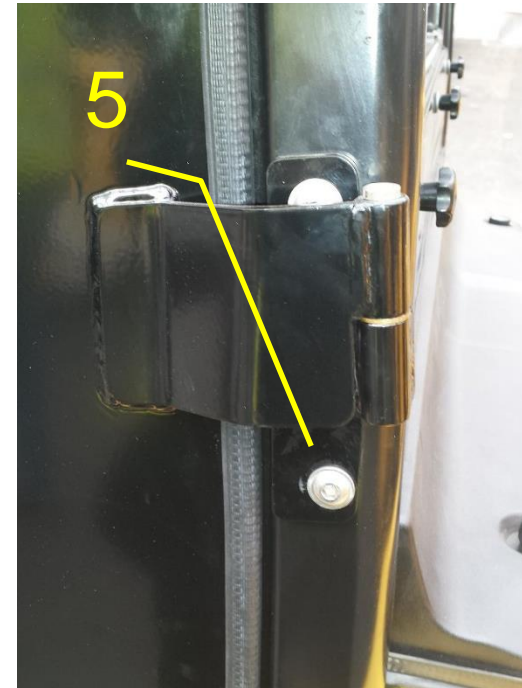

6. Put end set doors on the hinges. Adjust the doors position on such way that the gap between the seal and the inner OHG cavity was equal. Tighten the hinges screws

7. Screw the door lock latch (6) to the OHG original holes using M8x20. Adjust the door lock latch (6) position and fasten the screws



### Assembly of gas spring

8. On right profile of the OHG, remove the plastic plug (10)
9. Put embed M8 rivet nut.

10. Screw the gas spring bracket (7) using M8x25 screws

11. Screw the special screws (8) on the support (7) with a M8 nut

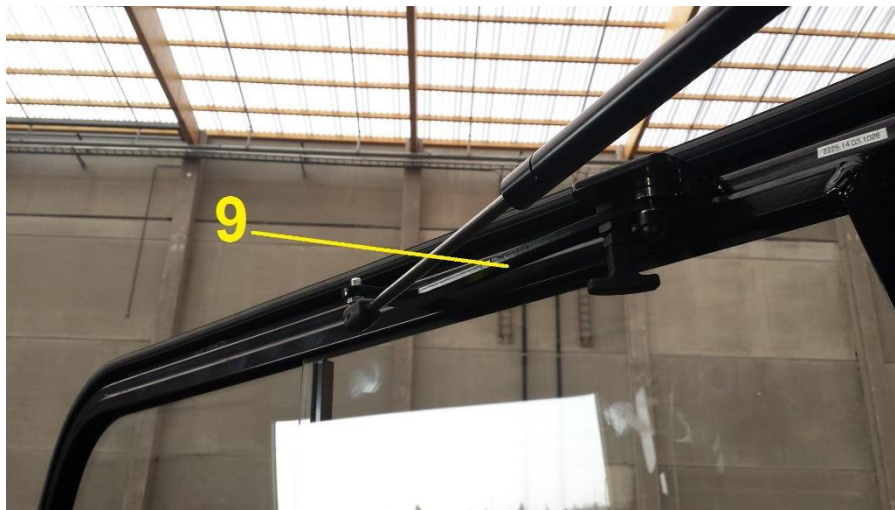
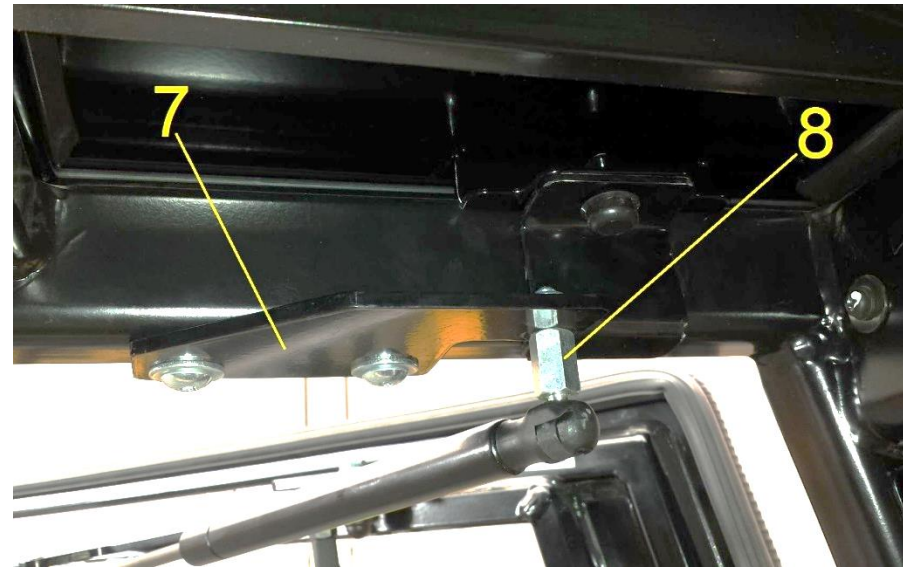

15. Screw the gas spring on the door support (9) with M8 nut

# E. Assembly of Electric Equipment

## 1. Scheme Electric bundle

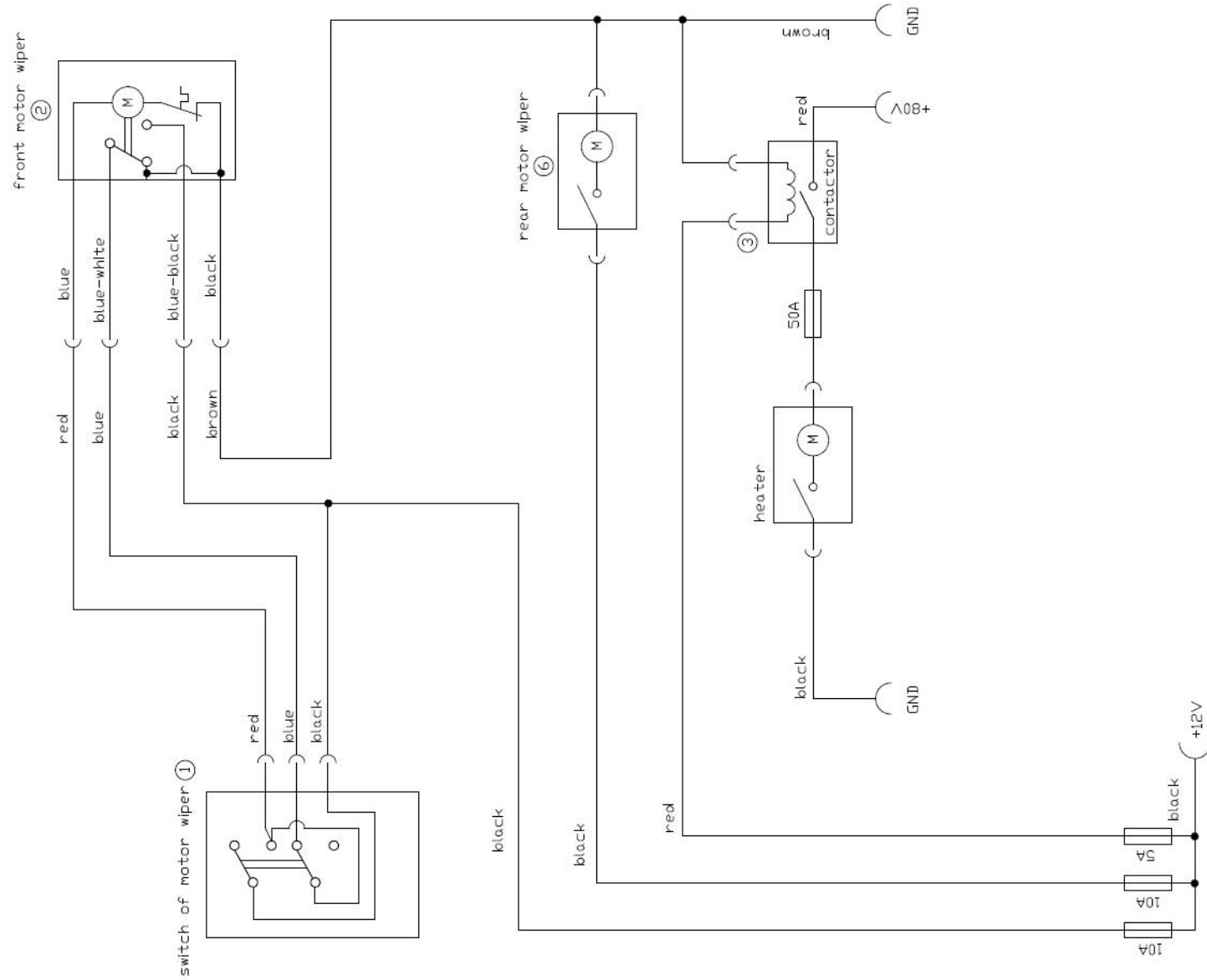

2. Remove the forklift floor
3. Unscrew the lower part of the dashboard.to access at the converter (1)
4. Attach the fuse wipers (front and rear) next to the converter (1)



5. Unroll the electric bundle provided and locate the various connectors electrical equipment provided under the scheme of the beam in paragraph
6. Fit the wiper motor (3) on the front glass
7. Drill a holes under the front motor wiper
8. Connect electric harness to the wiper motor
9. Attach arm and the blade







10. Pull the electric bundle of the rear wiper motor along the battery (follow the original bundle) and back up through the left rear profile. Bring out the wire through the point (5)

11. Attach the electric bundle on the rear panel with adhesive support

12. Attach the rear wiper motor on the glass

13. Connect the electric wire to the rear wiper motor

14. Attach the wiper arm and blade

15. Disconnect the connector (7) and locate the negative wire and the positive after contact. Solder the ground wire (or them) and connect the brown wire (or) black wire to the ignition switched



## F. Assembly of HEATER

1. Attach heater (1) on supports (2)
2. Present all heating + supports the right of the floor panel side, then locate the 4 holes of the support
3. Drill at  $\varnothing 9$ , then place the specials screws (3)
4. Screw the heater with M6 nuts



5. Remove the cover (4)

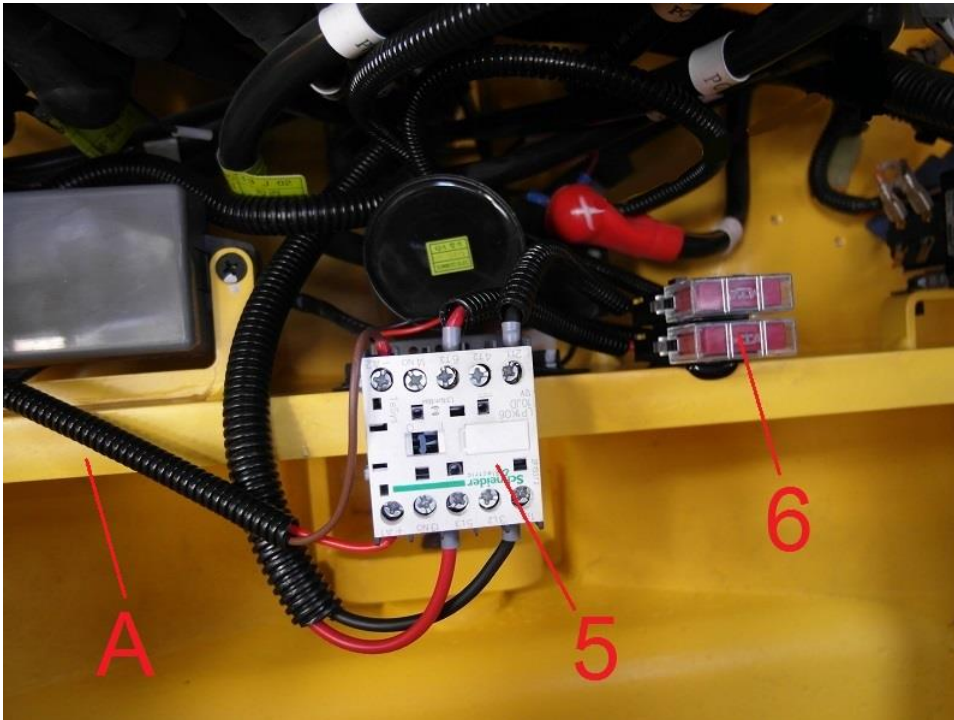

6. Attach on the sheet (A), the relay (5) and the fuses (6)

6. Locate the connector on the bundle heating. Get the wire in the floor plate of the forklift and bring it out through the point (7). Connect the beam heating

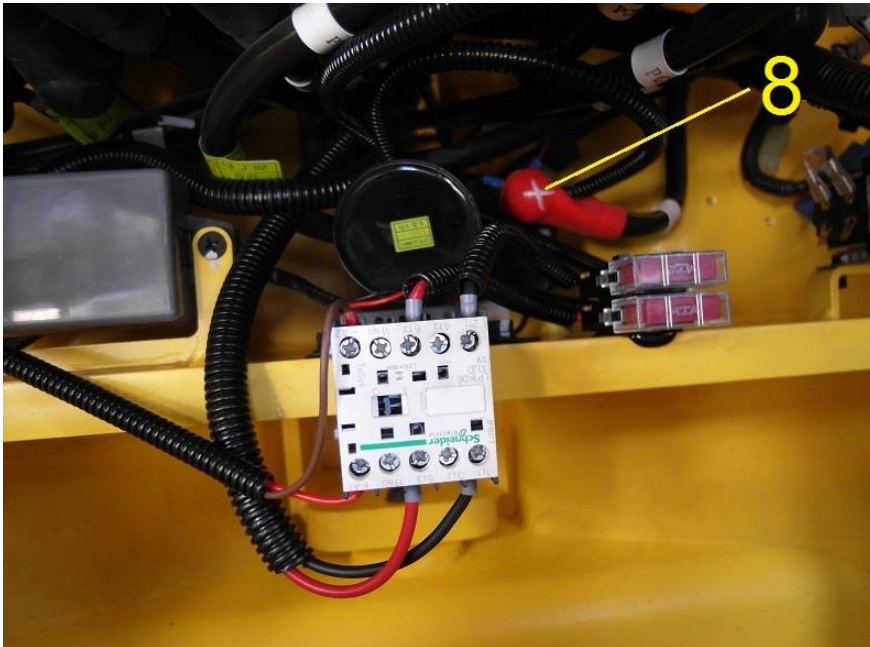

7. Connect the positive wire of heater electric bundle on the point (8)

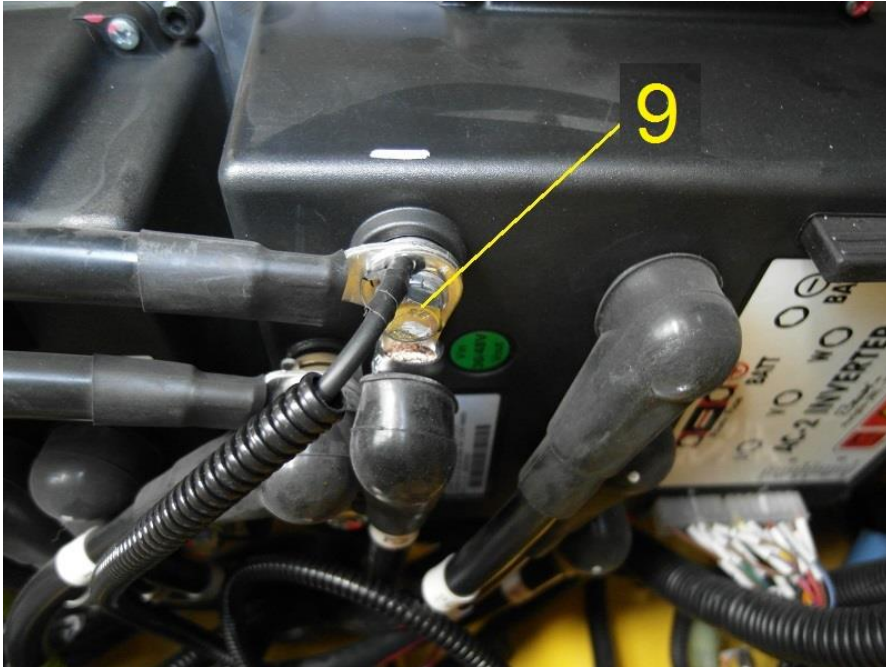

8. Connect the negative wire of heater electric bundle on point (9)